

V3458

Cylindrical luminaires

www.vulkan.eu



Decorative top-mounted luminaire with timeless, elegant design

- ✓ Dimensionally-stable and corrosion-resistant aluminium
- ✓ Stable roof fixation with three massive external aluminium rods
- ✓ Efficient thermal management thanks to built-in heat sink
- ✓ Interchangeable LED module with highly efficient high-power LEDs

Dimensional drawing in mm

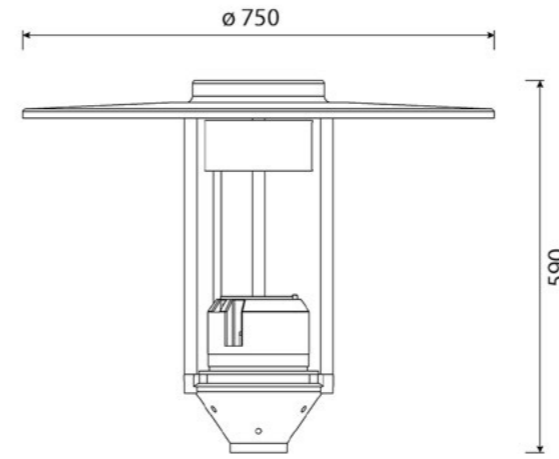

General specifications

Enclosure	Acrylic (PMMA) cylinder glass, clear, satin-finished at top
Rated luminous flux	1.449 lm - 4.476 lm, L90/B10 for 100.000 h
Light colour	4.000 K, 3.000 K, 2.700 K, 1.800 K, others on request
Rated input power	11 W - 36 W
Protection rating	I or II
Surface vulnerable to wind	0,1m ²
Weight	approx. 11 kg
Finish	DB 703, others on request
Accessories	See from page 80
Optics	Pages 24 - 26

Additional specifications

Housing	Dimensionally-stable and corrosion-resistant aluminium
Installation	Structurally secure three-point pole attachment in pole top for pole spigot diameter of 76 mm; reducing piece 60 mm to be ordered separately
Light regulation	Constant Lumen Management (CLM); autonomous performance reduction for operation in networks without a control line (Light Regulation Autarkic – LRA); performance reduction by switching off a control line (Light Regulation Twin – LRT); optional as "Control Ready", deliverable with Zhaga Book 18 socket and SR drive located above or under; 3 levelled lumen circuit-breaker upon request



Find more technical details
<https://www.vulkan.eu/en/decorative-lighting/v3458/>