

# V8466

## Bell-Shaped Luminaire/Schirmleuchte

**Vulkan**  
Nordeonbrand

Installation Instructions · Montageanleitung

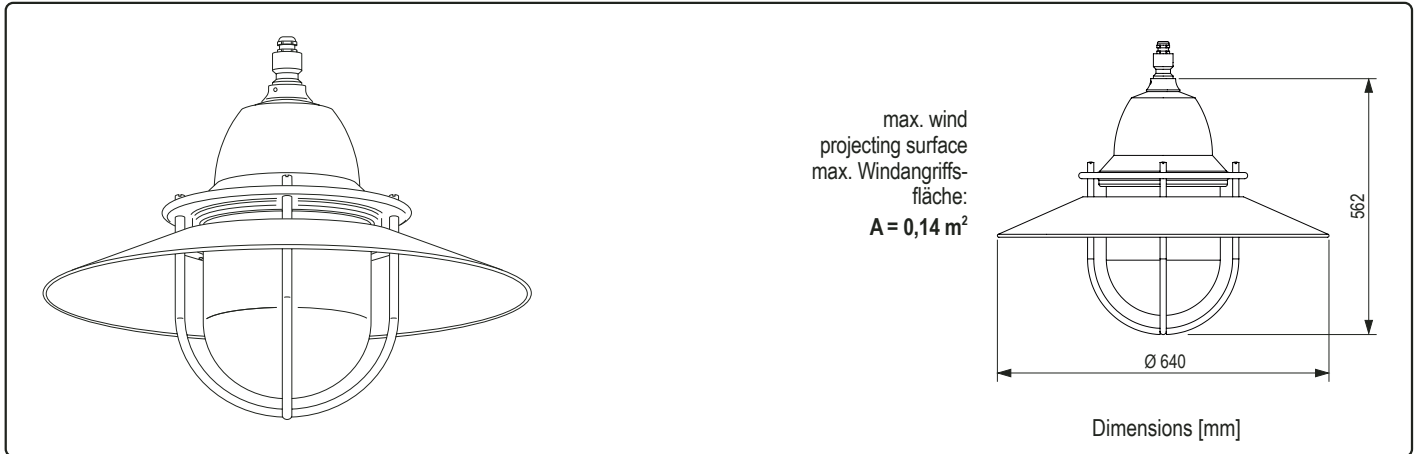

**IP65**



**CE**

**230 V**  
**50 Hz**



**kg**  
**11,0**

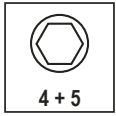

4 + 5



2

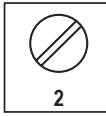

2

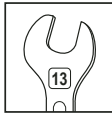

13

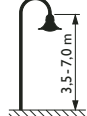

3.5-7.0 m

### Lamp technologies / Konventionelle Bestückung

Lamp/Lampe	Nominal power Nennleistung	System power Systemleistung
HSE-E/T (High-pressure sodium / Natriumhochdruck)	50 W	65 W
	70 W	85 W
	50/70 W	65/85 W
	70/50 W	85/65 W
CDO-ET/TT (Metal halide / Halogenmetaldampf)	70 W	85 W
LED technologies / LED-Bestückung	(driver 40 W / Treiber 40 W)	20 W (350 mA)
		27 W (500 mA)
		38 W (700 mA)

Inrush Current: max. 65 A / 110  $\mu$ s @ 230 V  
Einschaltstrom: max. 65 A / 110  $\mu$ s @ 230 V

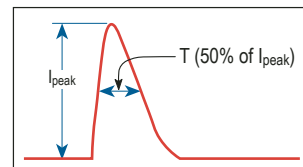

Max. drivers on MCB (16 A type-B): max. 21  
Max. Treiber MCB (16 A Typ-B): max. 21



Luminaire with high voltage ignitor

Switch off mains supply before opening!

Leuchte mit Zündgerät  
Vor Öffnen Spannung abschalten!



### General safety notes Allgemeine Sicherheitshinweise

- GB**
- Installation/maintenance only by skilled personnel.
  - Use luminaires only with complete protection covers!
  - During overhaul/maintenance only use original parts.
  - The light source contained in this luminaire shall only be replaced by the manufacturer or his service agent or a similar qualified person.
  - If any luminaire is subsequently modified, the person responsible for the modification shall be considered the manufacturer.
  - The manufacturer bears no liability for damage caused by inappropriate use or application.
- D**
- Montage/Wartung nur durch Fachkräfte.
  - Die Leuchte darf nur mit ihren vollständigen Schutzabdeckungen betrieben werden!
  - Bei Instandsetzung/Instandhaltung nur Originalteile verwenden.
  - Die Lichtquelle dieser Leuchte darf nur vom Hersteller oder einem von ihm beauftragten Servicetechniker oder einer vergleichbar qualifizierten Person ersetzt werden.
  - Werden nachträglich Änderungen an Leuchten vorgenommen, so gilt derjenige als Hersteller, der diese Änderung vornimmt.
  - Der Hersteller übernimmt keine Haftung für Schäden, die durch unsachgemäßen Einsatz entstehen.

Nordeon GmbH  
Rathenaustraße 2-6  
D-31832 Springe  
Germany  
Phone +49(0)5041 75 0  
[www.nordeon.com/www.vulkan.eu](http://www.nordeon.com/www.vulkan.eu)

# Mounting/Montage

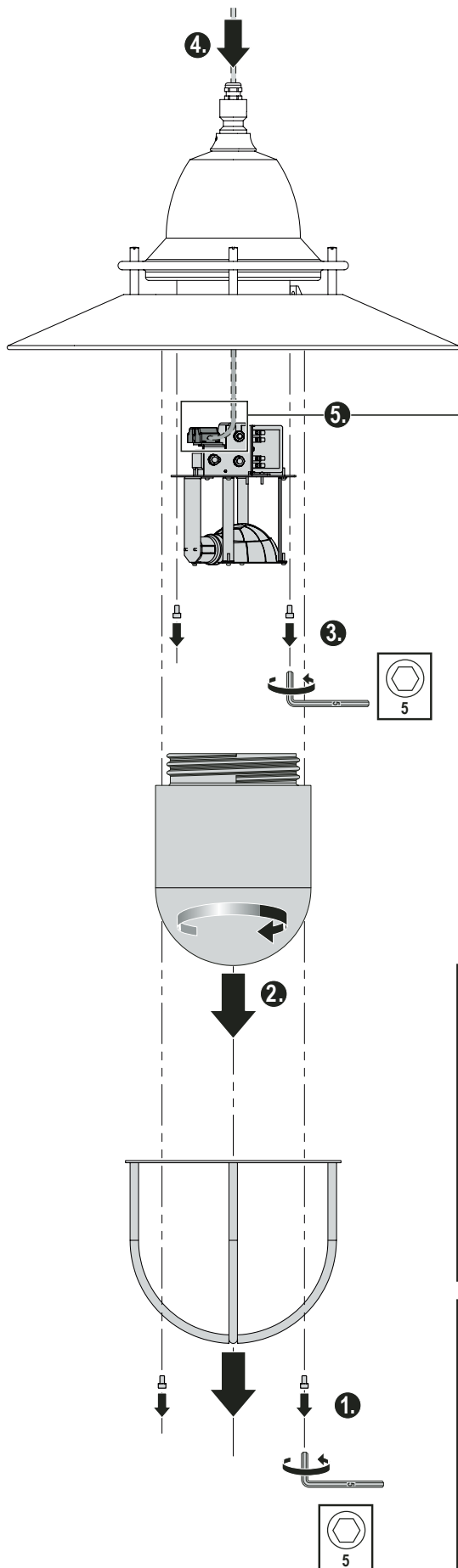

Electrical connection/Elektrischer Anschluss

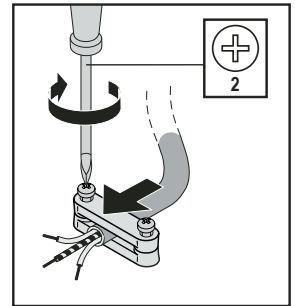
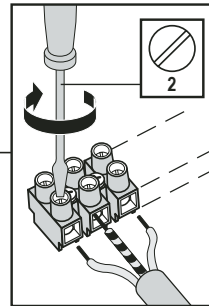

## Electrical connection/Elektrischer Anschluss

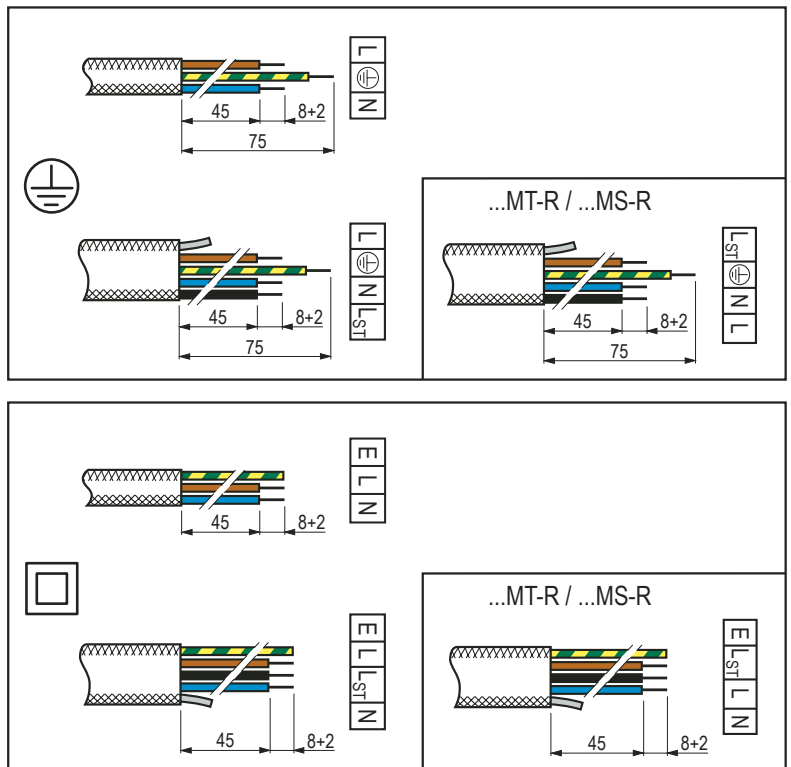

L = max. load / Ganznacht, L<sub>ST</sub> = power reduction / Halbnacht

# Mounting/Montage

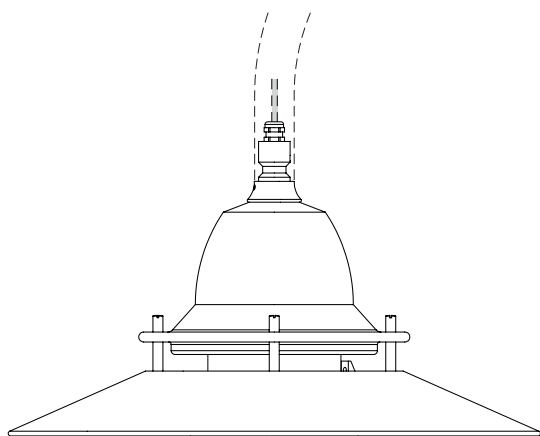

17 Nm

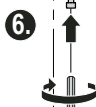

6.

7.

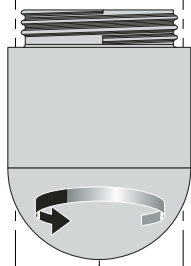

8.

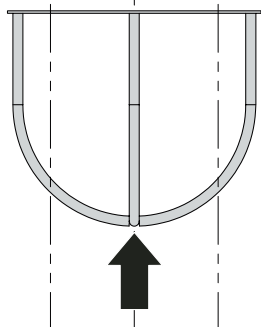

9.

17 Nm



**Note:**

Don't use the basket for LED luminaire !!!  
In case of refurbishment to LED with Vulkan LED-unit,  
please do not mount the basket (skip step 9.) !!!

**Hinweis:**

LED-Ausführungen immer ohne Korb betreiben !!!  
Bei Umrüstung auf LED mittels Vulkan LED-Umrüstsatzes,  
bitte den Korb (Schritt 9.) nicht installieren !!!

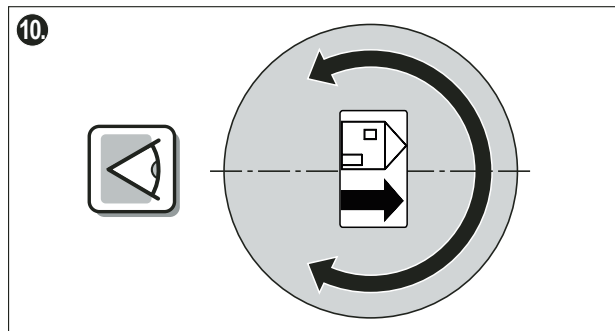
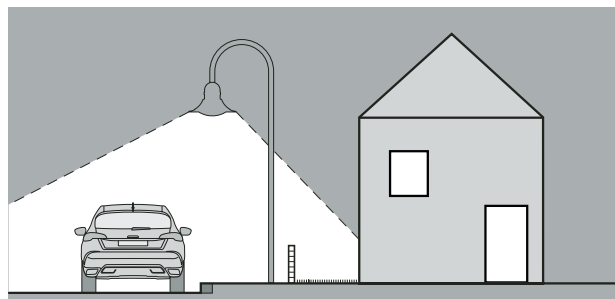

10.

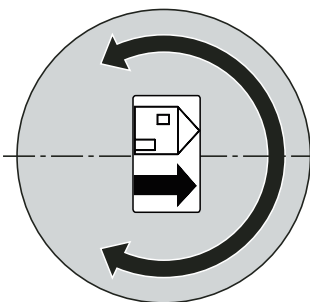

17 Nm



3x

11.

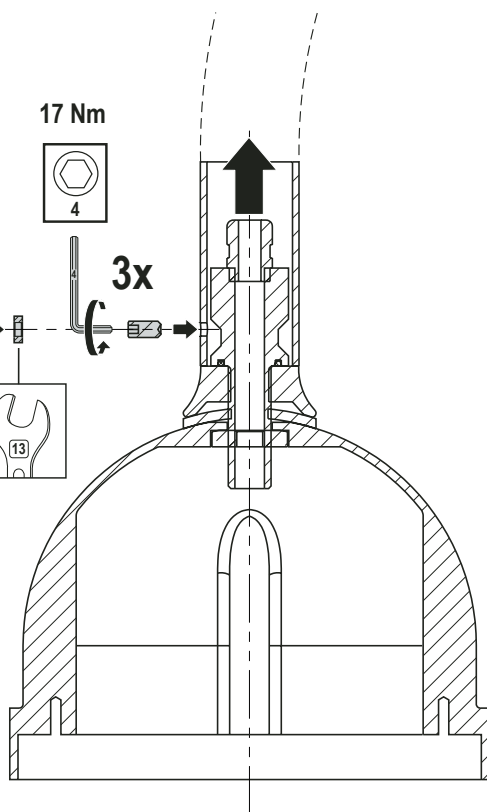
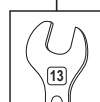

# Light regulation for LED version

## Leistungsreduzierung bei LED-Ausführung

### LRA - Light regulation antarctic/Autarke Lichtsteuerung

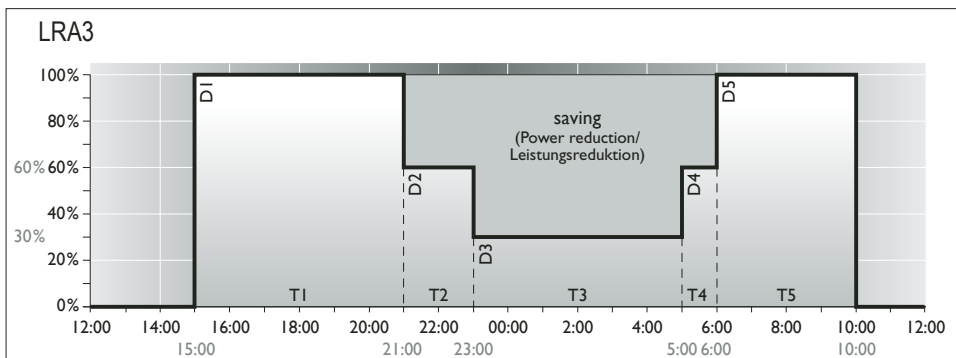
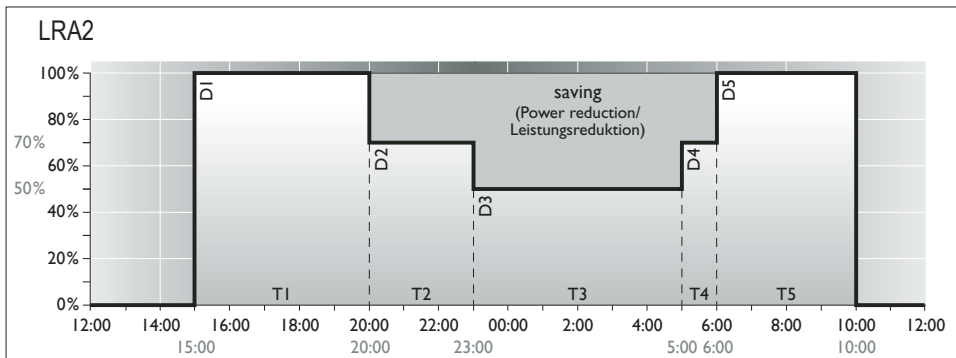
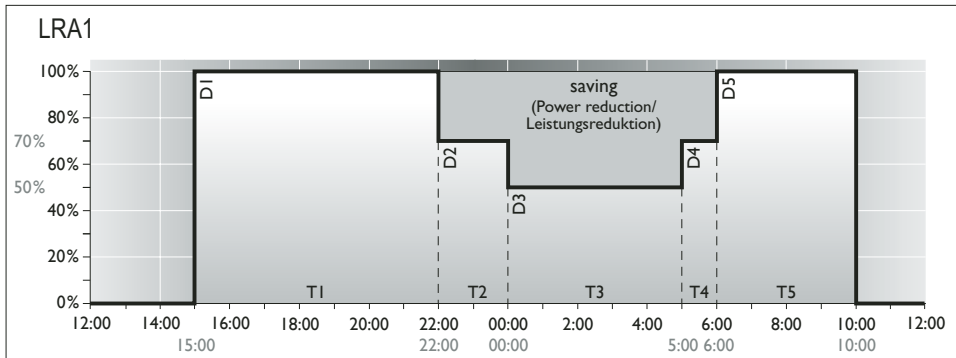

### LRT - Light regulation twin phases/Leistungsreduzierung mit Steuerphase

